

## GENERAL

To ensure the transition to other pipework or hoses, you will also find various adapters or bellows on the following pages. Other versions can either be found in the process technology catalogue or are available on request. Conductive and non-conductive coatings, as well as amber glass based on borosilicate glass or quartz glass versions are available on request.

We mainly use pipework with flanges from the collar flange system (KF) and flat flange system (PF). These have proven themselves in use and are constantly being further developed by us. We attach great importance to the compatibility of the components and thus guarantee you constant availability and accuracy of fit of the components.



KF bellows

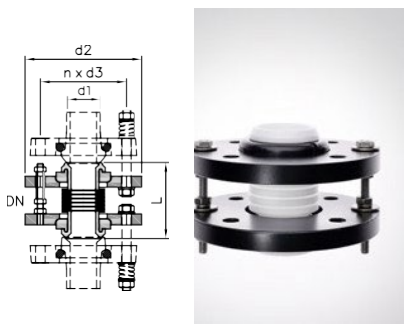

Nominal size DN	Length L [mm]	Diameter d1 [mm]	Diameter d 2 [mm]	Diameter n x d3 [mm]	Order no.
15	75 +/-5	23	95	50,3 x 7	CBG015-K
25	75 +/-5	34	115	85,4 x 9	CBG025-K
40	100 +/-5	51	150	110,4 x 9	CBG040-K
50	100 +/-6	63	165	125,4 x 9	CBG050-K

- Metal / glass on request

PF bellows glass-glass

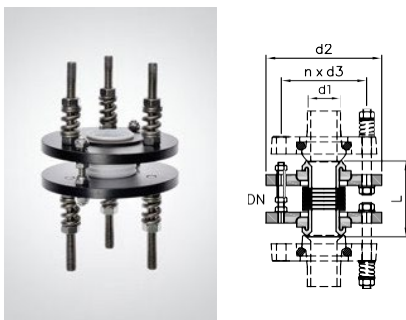

Nominal size DN	Length L [mm]	Diameter d1 [mm]	Diameter d2 [mm]	Diameter n x d3 [mm]	Order no.
15	35 +/-5	23	80	50,3 x 7	CBG015-P
25	43 +/-5	34	105	70,3 x 9	CBG025-P
40	52 +/-5	48	125	86,3 x 9	CBG040-P
50	50 +/-6	61	140	98,3 x 9	CBG050-P

- Version for glass-to-metal connection on request

## Suction pieces with standard ground joint core

NS	Execution	Order no.
14/23	A	GSG 01080 01
29/23	A	GSG 01080 03
45/40	A	GSG 01080 04
14/23	B	GSG 01081 01
29/23	B	GSG 01081 03
45/40	B	GSG 01081 04
14/23	C	GSG 01085 01
29/32	C	GSG 01085 03
45/40	C	GSG 01085 04

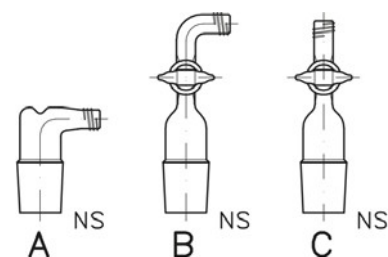

- With GL14 glass thread as standard
- also available with Olive D 11 on request
- Version B + C have a standard tap with 3 mm hole

## Suction pieces with standard ground joint sleeve

NS	Execution	Order no.
14/23	A	GSG 01082 01
29/23	A	GSG 01082 03
45/40	A	GSG 01082 04
14/23	B	GSG 01083 01
29/23	B	GSG 01083 03
45/40	B	GSG 01083 04
14/23	C	GSG 01086 01
29/32	C	GSG 01086 03
45/40	C	GSG 01086 04

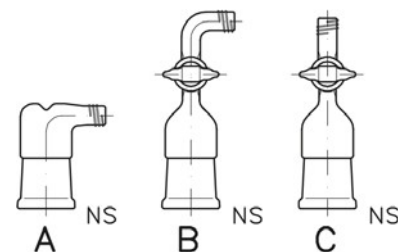

- With GL14 glass thread as standard
- also available with Olive D 11 on request
- Version B + C have a standard tap with 3 mm hole

Transition pieces sleeve/core

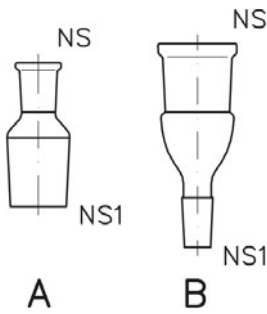

NS	NS 1	Execution	Order no.
14/23	29/32	A	GSG 01016 02
29/23	45/40	A	GSG 01016 04
29/32	60/46	A	GSG 01016 05
29/32	14/23	B	GSG 01017 02
45/40	29/32	B	GSG 01017 04
60/46	45/40	B	GSG 01017 05

- Very short design to achieve low overall height
- Spherical ground joint shells on the transition pieces are also available in millimetre versions

Transition pieces shell/core

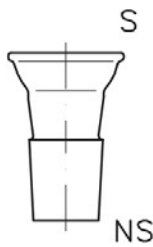

S	NS	Order no.
19	14/23	GSG 07010D 01
19	29/32	GSG 07010D 03
35	29/32	GSG 07010D 04
40	29/32	GSG 07010D 05
51	29/32	GSG 07010D 06
64	45/40	GSG 07010D 07

- Very short design to achieve a low overall height
- Spherical ground joint shells on the transition pieces are also available in millimetre versions

Transition pieces sleeve/ball

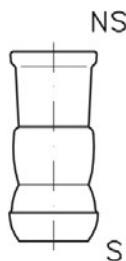

NS	S	Order no.
14/23	19	GSG 07016D 01
29/32	35	GSG 07016D 03
29/32	40	GSG 07016D 04
29/32	51	GSG 07016D 05
29/32	64	GSG 07016D 06
45/40	64	GSG 07016D 07

- Very short design to achieve a low overall height
- Spherical ground joint shells on the transition pieces are also available in millimetre versions

Transition pieces core/core

NSNS 1		Order no.
14/23	14/23	GSG 01015K 01
29/32	29/32	GSG 01015K 03
14/23	29/32	GSG 01015K 05

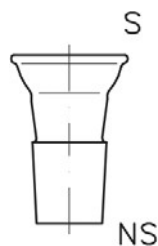

- Very short design to achieve low overall height
- Spherical ground joint shells on the transition pieces are also available in millimetre versions

Transition pieces sleeve/sleeve

NSNS 1		Order no.
14/23	14/23	GSG 01015H 01
29/32	29/32	GSG 01015H 03
14/23	29/32	GSG 01015H 05

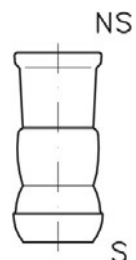

- Very short design to achieve low overall height
- Spherical ground joint shells on the transition pieces are also available in millimetre versions

Taper ground hollow plug without grease groove

NS	Order no.
7/16	GSG 01014 01
10/19	GSG 01014 02
12/21	GSG 01014 03
14/23	GSG 01014 04
19/26	GSG 01014 06
29/32	GSG 01014 08
45/40	GSG 01014 09

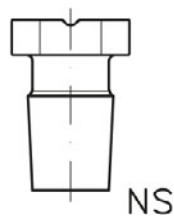

- With flat base and safety groove

## Closures with conical ground joint sleeve

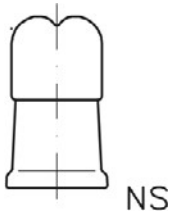

NS	Order no.
14/23	GSG 01084 01
19/26	GSG 01084 02
29/32	GSG 01084 03
45/40	GSG 01084 04

- Caps have a safety groove

## Clasps with spherical bead

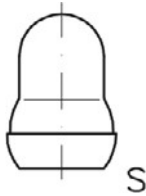

S	Order no.
13	GSG 07033D 01
19	GSG 07033D 02
29	GSG 07033D 03
35	GSG 07033D 04
40	GSG 07033D 05
51	GSG 07033D 06
64	GSG 07033D 07

- All spherical beads also available in millimetre versions

## Closures with spherical ground joint

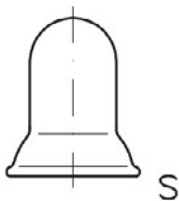

S	Order no.
13	GSG 07034D 01
19	GSG 07034D 02
29	GSG 07034D 03
35	GSG 07034D 04
40	GSG 07034D 05
51	GSG 07034D 06
64	GSG 07034D 07

- All spherical beads also available in millimetre versions